

# LED Canopy Fixture Installation Instruction

COMMERCIAL LED  
www.comm-led.com  
CLCN11-75W-SAAN-50K

## Cautions:

1. Can not use the electric generator to test the LED lamp.
2. Please abide by related country, regional and local law and regulations when install this fixture.
3. Please turn off the power before installation or maintenance.
4. Proper earth grounding is required to ensure safety.

## Notice:

1. To avoid possibility of electrical shock or fire, the installation personnel must have professional electric knowledge.
2. Please wear gloves to avoid injury before installation.
3. If any smoke or spark of the wire happened, please turn off the power immediately and notify relevant personnel.

## Attention:

1. Please check if there is any damage during shipping. If so, please contact manufacturer timely.
2. Please read the installation instruction carefully to check whether all the accessories are complete. After confirmation, then install the fixture according to installation steps.

## Wiring Diagram:

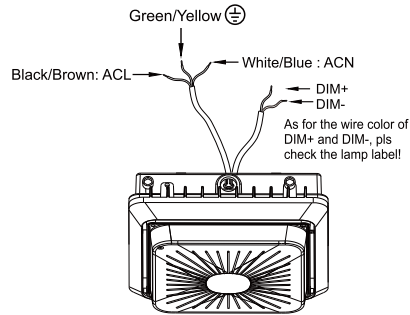

## ☑ Installation Method I :

1. Disassemble the driver box cover by loosen the two screws on the driver box; Figure 1-1
2. Loosen the 3/4 plug on the driver box cover by screwdriver; Figure 1-2
3. Fix the driver box cover on the 3/4 tube; Figure 1-3
4. Insert the mounting hole of radiator horizontally to the shaft of driver cover; Figure 1-4
5. Connect the input line and ground; If the fixture is equipped with sensor, adjust the sensor settings. Take relevant waterproof measures after the wires are connected ;Figure 1-5
6. Turn the radiator up then cover the driver box, Figure 1-6
7. Lock the two cap screws, the product is installed. Figure 1-7

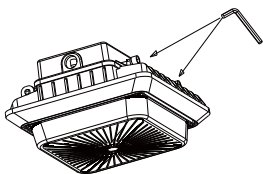

Figure 1-1

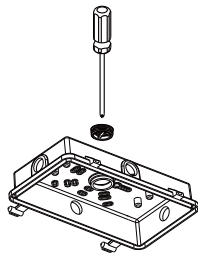

Figure 1-2

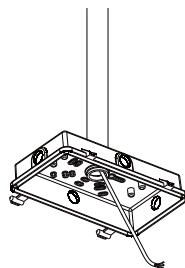

Figure 1-3

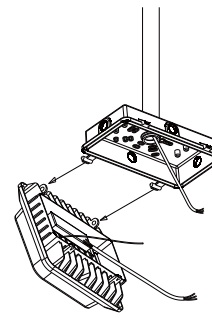

Figure 1-4

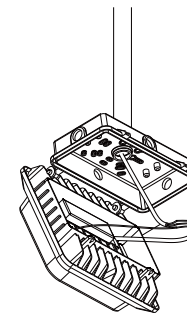

Figure 1-5

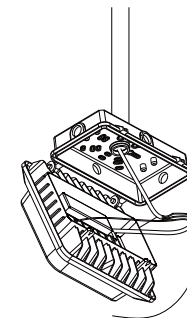

Figure 1-6

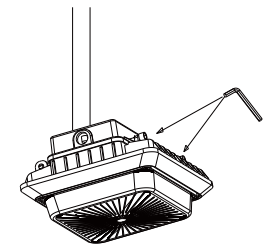

Figure 1-7

## ☑ Installation Method II :

1. Disassemble the driver box cover by loosen the two screws on the driver box; Figure 2-1
2. Loosen the 3/4 plug on the driver box cover by screwdriver; Figure 2-2
3. Drill the holes on the ceiling accordingly to fit the plate; Figure 2-3
4. Fix the driver box cover on the ceiling; Figure 2-4
5. Insert the mounting hole of radiator horizontally on the shaft of driver cover; Figure 2-5
6. Connect the input line and ground; If the fixture is equipped with sensor, adjust the sensor settings; Take relevant waterproof measures after the wires are connected ;Figure 2-6
7. Turn the radiator up then cover the driver box, Figure 2-7
8. Lock the two cap screws, the product is installed. Figure 2-8

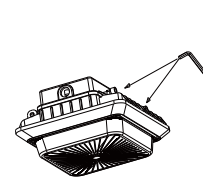

Figure 2-1

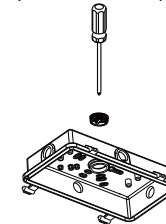

Figure 2-2

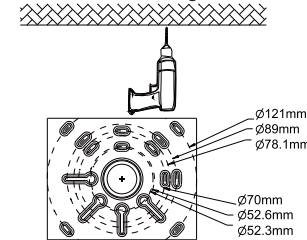

Figure 2-3

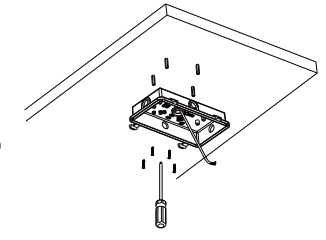

Figure 2-4

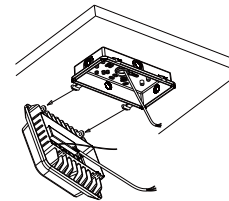

Figure 2-5

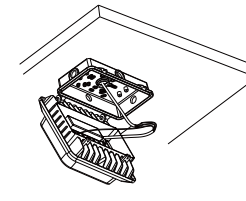

Figure 2-6

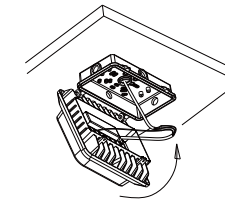

Figure 2-7

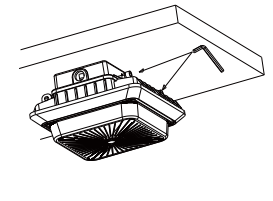

Figure 2-8

## ☐ Installation Method III :

1. Disassemble the driver box cover by loosen the two screws on the driver box; Figure 3-1
2. Loosen the 3/4 plug on the driver box cover by screwdriver; Figure 3-2
3. Drill holes on the ceiling; Figure 3-3
4. Fix the driver box cover on the ceiling; Figure 3-4
5. Fix the lower bracket on the driver box cover; Figure 3-5
6. Align with the holes of upper and lower bracket; tighten with screws; Figure 3-6
7. Insert the mounting hole of radiator horizontally on the shaft of driver cover; Figure 3-7
8. Use M20 waterproof connector when connecting AC wire or dimming wire, take relevant waterproof measures at both sides of inlet. Figure 3-8
9. Connect the input line and ground; If the fixture is equipped with sensor, adjust the sensor settings; Take relevant waterproof measures after the wires are connected ;Figure 3-9
10. Turn the radiator up then cover the driver box, Figure 3-10
11. Lock the two cap screws, the product is installed. Figure 3-11

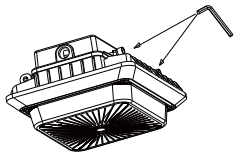

Figure 3-1

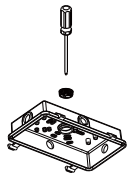

Figure 3-2

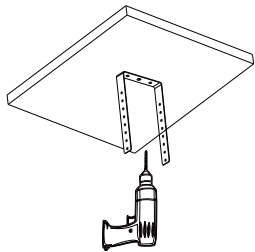

Figure 3-3

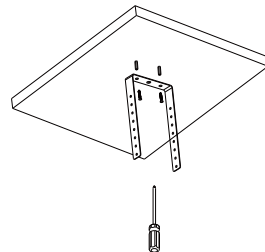

Figure 3-4

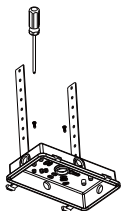

Figure 3-5

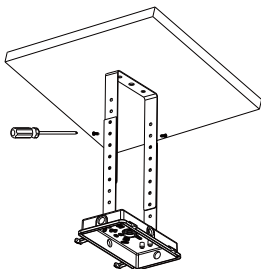

Figure 3-6

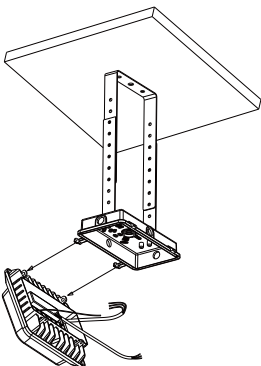

Figure 3-7

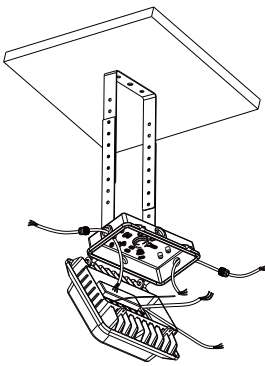

Figure 3-8

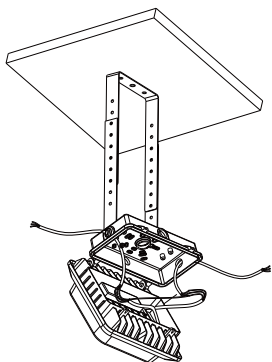

Figure 3-9

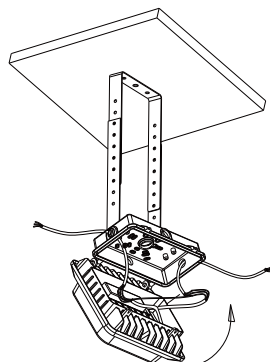

Figure 3-10

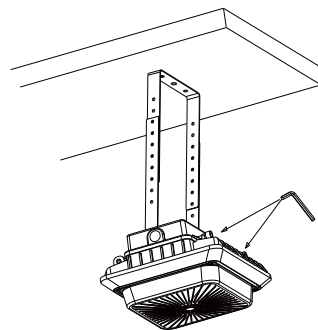

Figure 3-11

### Warning / Avertissement

MIN 75°C SUPPLY CONDUCTOR

THIS PRODUCT MUST BE INSTALLED IN ACCORDANCE WITH THE APPLICABLE INSTALLATION CODE BY A PERSON FAMILIAR WITH THE CONSTRUCTION AND OPERATION OF THE PRODUCT AND THE HAZARDS INVOLVED.

LES FILS D'ALIMENTATION 75°C MIN

CE PRODUIT DOIT ÊTRE INSTALLÉ SELON LE CODE D'INSTALLATION PERTINENT, PAR UNE PERSONNE QUI CONNAÎT BIEN LE PRODUIT ET SON FONCTIONNEMENT AINSI QUE LES RISQUES INHÉRENTS.