

LED Linear High Bay Installation Instruction

2-2.3. DC PIR Sensor / Motion Sensor (Both sensor are with same installation)

Step1. Remove the sensor cap from the Zhaga base (Figure 17)

Step2. Twist-lock the sensor into the Zhaga base (Figure 18).

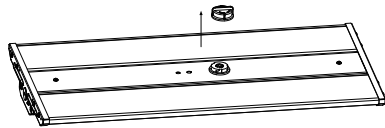

Figure 17

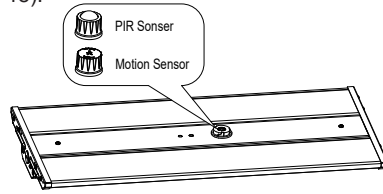

Figure 18

3.Backup driver:

Step1. Knock off the knockout hole on the back of the fixture, take out the wires from the knockout hole (Figure 19), open the front cover of the fixture, and knock out the two knockout holes on the cover (Figure 20);
 Step2. Open the cover of the backup driver box, install the backup driver box at the corresponding position on the back of the fixture (Figure 21), connect the wires correspondingly according to the marking instructions on the wire, mount the buttons and indicators of backup driver on the front cover of the fixture (Figure 22), then fix the cover to the fixture.

Step3. After mounting, choose suitable wiring knock out and do wiring according to local standard and code.

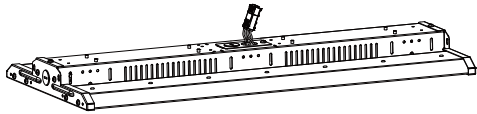

Figure19

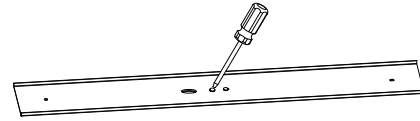

Figure20

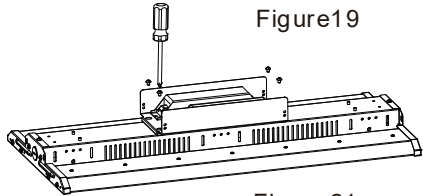

Figure21

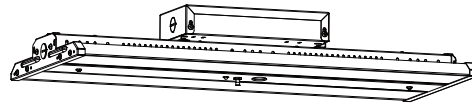

Figure22

MIN 90 °C SUPPLY CONDUCTORS

THIS PRODUCT MUST BE INSTALLED IN ACCORDANCE WITH THE APPLICABLE INSTALLATION CODE BY A PERSON FAMILIAR WITH THE CONSTRUCTION AND OPERATION OF THE PRODUCT AND THE HAZARDS INVOLVED

LES FILS D'ALIMENTATION 90 °C MIN

CE PRODUIT DOIT ÊTRE INSTALLÉ SELON LE CODE D'INSTALLATION PERTINENT, PAR UNE PERSONNE QUI CONNAÎT BIEN LE PRODUIT ET SON FONCTIONNEMENT AINSI QUE LES RISQUES INHÉRENTS

Cautions:

1. Can not use the electric generator to test the LED light.
2. Please abide by related country, regional and local law and regulations when install this fixture.
3. Please turn off the power before installation or maintenance.
4. Proper earth grounding is required to ensure safety.

Notice:

1. To avoid possibility of electrical shock or fire, the installation personnel must have professional electric knowledge.
2. Please wear gloves to avoid injury before installation.
3. If any smoke or spark of the wire happened, please turn off the power immediately and notify relevant personnel.
4. Please use listed strain relief bushing when connection the supply cord to the outlet box.

Attention:

1. Please check if there is any damage during shipping. If so, please contact manufacturer timely.
2. Please read the installation instruction carefully to check whether all the accessories are complete. After confirmation, then install the fixture according to installation steps.

Wiring Diagram & Instruction:

3 dimming functions are available in this high bay light:

1. Constant current can be achieved by 0-10VDC dimming;
2. PWM signal dimming;
3. Variation of resistance unit dimming.

Two wiring method:

1. Conduit connection,
2. Flexible cord for connection.

Wiring Instruction

- L:Black
- N:White
- ⊕: Green/Yellow
- DIM + : Purple
- DIM - : Pink

Backup Driver Wiring

- Step1. Open junction box with screw driver
- Step2. Connect the input wires on each backup driver and fixture driver via suitable knock out, then complete the junction box.

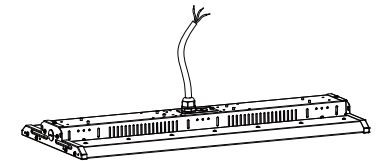
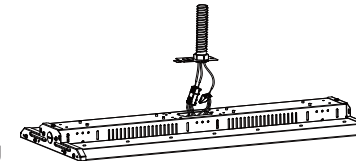

Description:	
This product is 0-10V dimming, below dimmers are recommended:	
Brand	Model
LUTON	NTSTV-DV
LEVITON	DS710-10Z / IP710
LEGRAND	RH4FBL3PW

Wiring Instruction

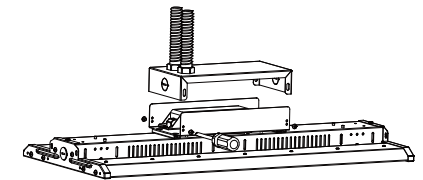
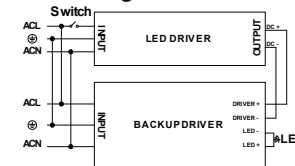

Please choose the appropriate dimming way according to your needs. You can also choose not to use this function.
 *The product can not be connected to a dimming device when it's equipped with Motion Sensor.

Wattage Adjustable

- Step1. Adjust to get the required wattage according to the wattage label.

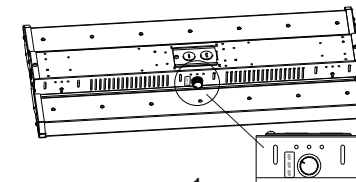

Three Installation: Chain/Cable Installation, 3/4"NPT Installation, Surface Mounting / Pendant Mounting (Please choose the most suitable installation method for the purchased product as per your needs)

A.Hanging Installation: (Chain/Cable)

- Step1.Hook up the chain; (Figure 1)
- Step2.Connect the chain with fixture; (Figure 1)
- Step3. Fix the chain on the rail, adjust the chain length as per need; (Figure 1)
- Step4.After the fixing , choose suitable wiring knock out, do wiring according to local standard and code. (for wiring method (including backup driver wiring): Conduit connection or flexible cord for connection)

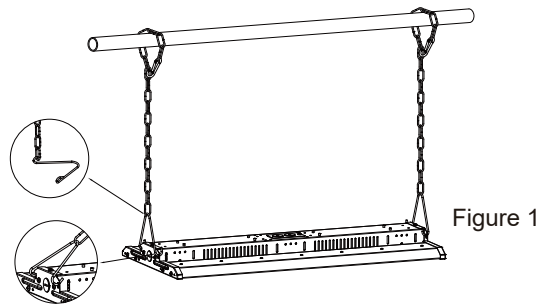

Figure 1

B.3/4"NPT Installation: (If this bracket is used for the fixture,Backup driver solution cannot be chosen)

- Step1.Mount the bracket on 3/4"NPT (Figure 2)
 - Step2. Lock fixture on the bracket (Figure 3);
 - Step3. Do wiring according to local standard and code.
 - Step4 Lock side brackets with screw driver (Figure 4).
- (for wiring method (including backup driver wiring) : only Conduit connection)

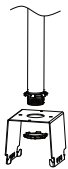

Figure 2

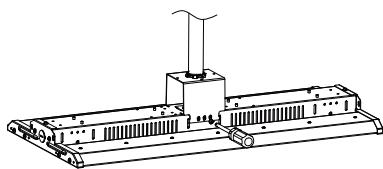

Figure 3

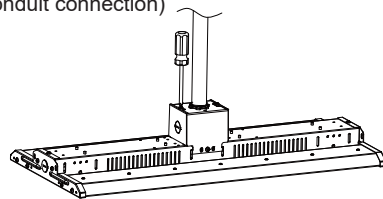

Figure 4

C.Surface Mounting/ Pendant Mounting:

- Step1.Mount the bracket on the rail or ceiling (Figure 5);
- Step2. Mount bolt on the rail or ceiling, and mount the fixture bracket on the bolt (Figure 6); and then install the fixture. (Figure 7).
- Step3. After mounting, choose suitable wiring knock out and do wiring according to local. (for wiring method (including backup driver wiring) : only Conduit connection)

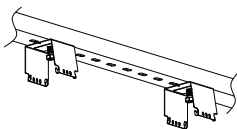

Figure 5

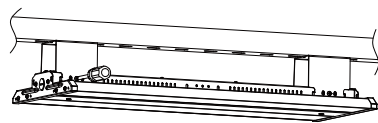

Figure 6

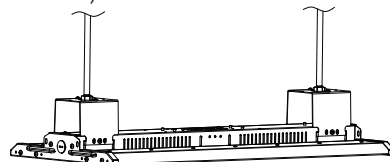

Figure 7

Extra Accessory Option Installation: 1:Wire Guard, 2:Motion Sensor / PIR Sensor, 3:Backup driver

1.Wire Guard:(Purchase the correct size wire guard from manufacturer)

- Step1. Mount the wire guard on the fixture with screws (Figure 8)

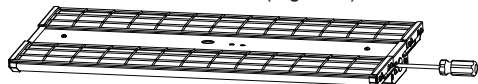

Figure 8

2-1. AC Motion Sensor / PIR Sensor (Both sensor are with same installation)

- Step1.Open the face cover with screw driver (Figure 9)
- Step2.Knock out the side cover, mount the sensor on the side, do wiring according to instruction on sensor (Figure 10).
- Step3.Put face cover back with screw driver (Figure 11).

Wiring Instruction

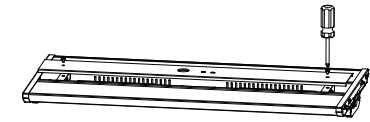
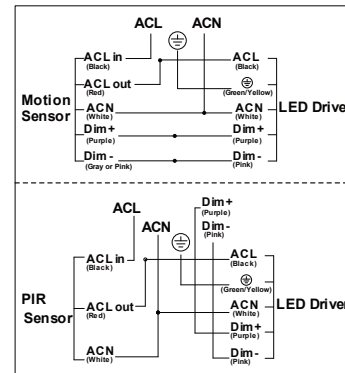

Figure 9

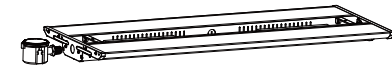

Figure 10



Figure 11

2-2.1. DC Motion Sensor / PIR Sensor (Both sensor are with same installation)

- Step1. Open the face cover with screw driver (Figure 12)
- Step2. Knock off the knockout on the cover, install the sensor on the cover(Figure 13), and connect the wiring according to the wiring instructions.Step3.Assemble the cover back onto the fixture (Figure 14) After the fixture is light on, use the remote control to adjust the working mode of the sensor as per your need.

Wiring Instruction

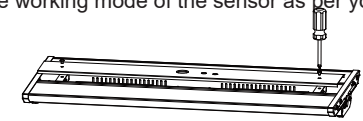
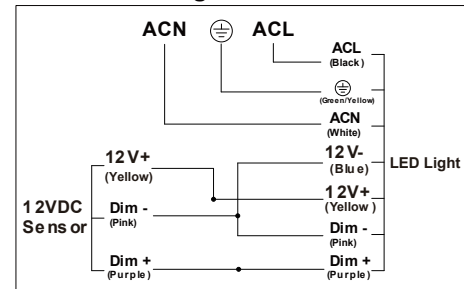

Figure 12

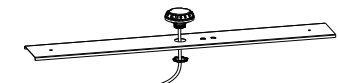

Figure 13

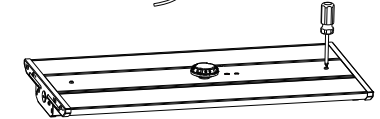

Figure 14

2-2.2. DC Motion Sensor / PIR Sensor:(Both sensors are with the same installation method)

- Step1. Use a screwdriver to remove the 1/2 plug from the sensor;(Figure 15)
- Step2. Twist-lock the DC sensor to the base to make it work properly, use a remote control to adjust the working mode as per demand.(Figure 16)

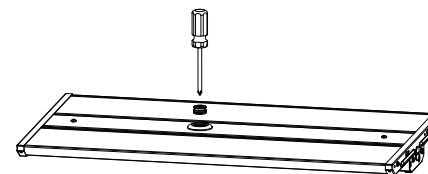

Figure 15

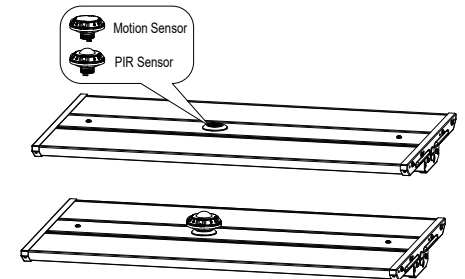

Figure 16