

# LED Back-lit Panel Light

## INSTRUCTION MANUAL

PLEASE READ INSTRUCTION BEFORE COMMENCING INSTALLATION AND RETAIN FOR FUTURE REFERENCES.  
 ! Electrical products can cause death or injury, or damage to property. If in any doubt about the installation or use of this product, consult a competent electrician

Product Model	Power	Working Current	Input Voltage	Luminous Efficacy	CCT	Viewing Angle	Ra	PF	Dimmable	Warranty
CLP12-2X2-BLS-35W-TUN	25W/30W/35W	0.385A	AC100-277V	125lm/W	3500K   4000K   5000K	120°	≥80	≥0.9	0-10V	5 years
CLP12-2X2-BLS-40W-TUN	30W/35W/40W	0.44A								
CLP12-1X4-BLS-35W-TUN	25W/30W/35W	0.385A								
CLP12-1X4-BLS-40W-TUN	30W/35W/40W	0.44A								
CLP12-2X4-BLS-40W-TUN	30W/35W/40W	0.44A								
CLP12-2X4-BLS-50W-TUN	30W/40W/50W	0.55A								

Note: Above is the normal parameters, the following functions can be achieved according to customers requests.  
 UGR<19

## Warning

- \* LED Panels are not suitable for using in wet loations
- \* Please keep the LED Panel away from any corrosive substance, and please use dry cloth when you clean it
- \* LED Panel can only be installed by a qualified electrician.
- \* Before installation or maintenance, please disconnect the power to prevent electric shock.

## Recessed Installation

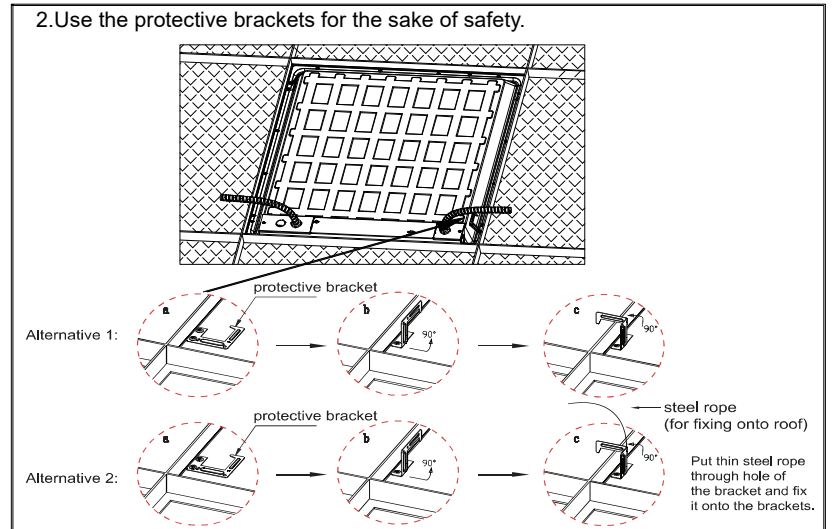
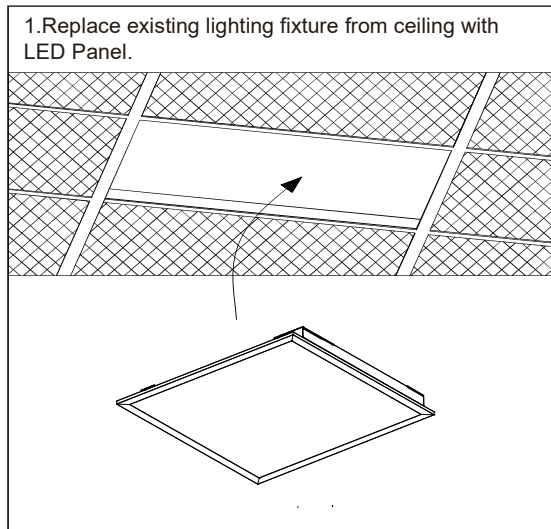

## Installation Guide

1. Unscrew the driver cover.

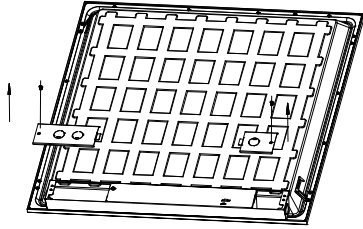

2. Connect the conduit to the driver box.

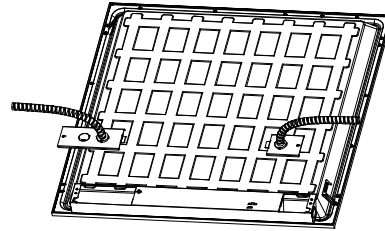

3. Connect other wires separately.

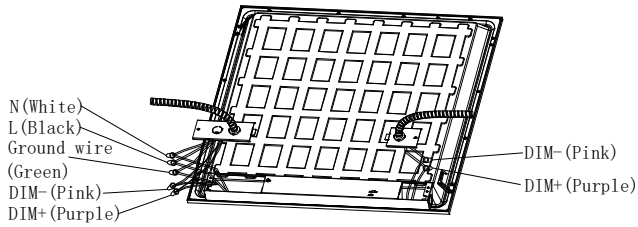

4. Put back the driver cover and fix it by screw. Select adjustable power and color temperature.

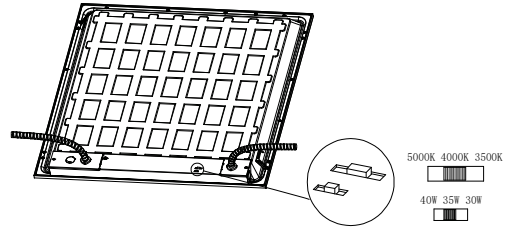

\* Optional accessories  
If there are more wires, you can choose to use enlarged junction box.

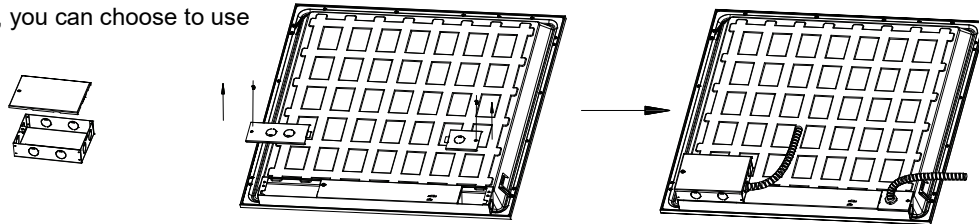

## Suspension kit Installation

1. Drill two holes in the ceiling, and put the anchors into hole, then insert the wire rope and screw.

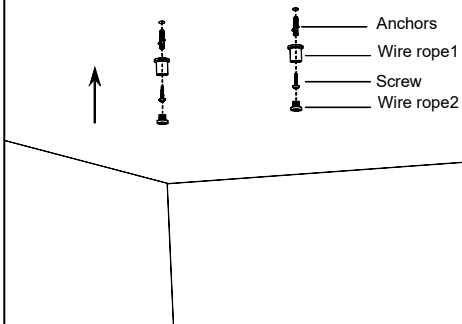

2. Adjusting the hanging rope making the panel in a horizontal state.

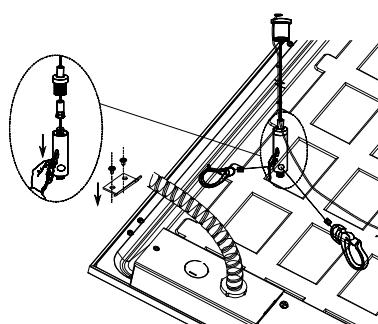

3. The installation is finished.

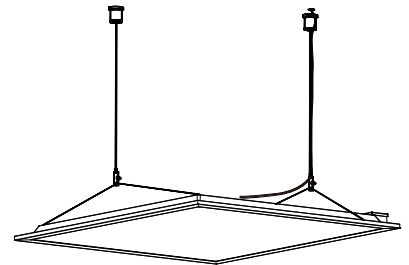

Note: 2\*2 1/4\*4 1/2\*4ft: 2 pcs suspension kits needed for installation.

The Installation must be carried out by a qualified electrician.